

Retraflex®

Système de flexible
rétractable

**Retractable
hose system**

Sistema de manguera
retráctil

*Einzugschlauch
System*



retraflex.com

UNE INNOVATION POUR VOUS SIMPLIFIER LA VIE

L'unique système de flexible rétractable est une innovation indispensable pour l'utilisation optimale de votre aspirateur central.

Le concept est simple: le flexible, de la longueur choisie, est dissimulé dans le réseau de conduits du système d'aspiration, derrière sa prise dédiée. Vous devez nettoyer la maison ou un petit dégât dans la cuisine? Il vous suffit d'ouvrir la prise, de sortir la longueur de flexible dont vous avez besoin à l'instant, d'y connecter vos accessoires et de démarrer votre appareil depuis la prise. Rien de plus facile! Lorsque vous avez terminé, le flexible se rétracte rapidement grâce à la force d'aspiration de votre appareil.

AN INNOVATION TO MAKE YOUR LIFE EASIER

The unique retractable hose system is an essential innovation for the optimal use of your central vacuum system.

The concept is simple: a flexible hose is hidden within the piping system, behind its dedicated inlet. You have to clean the house or a little mess in the kitchen? Simply open the inlet, pull out the length of hose you need, attach your tools and start your central vacuum unit directly from the inlet. Nothing's easier! When you are done, the hose rapidly retracts with the suction power of your central vacuum.

UNA INNOVACIÓN PARA SIMPLIFICAR LA VIDA

Este sistema único es una innovación imprescindible para una utilización óptima de su aspirador central.

El concepto es sencillo: La manguera queda escondida en el sistema de conductos, detrás de una toma. Solo se estira la longitud necesaria. Basta con abrir la toma, estirar la longitud de manguera necesaria en el momento, conectar los accesorios de su elección y encender el aparato desde la toma. ¡Nada más fácil! Cuando hayan terminado, la manguera se guarda gracias a la fuerza de aspiración de su aparato.

EINE INNOVATION UM IHNEN DAS LEBEN ZU VEREINFACHEN

Das einzigartige Einzugschlauchsystem ist eine unerläßliche Innovation für die optimale Ausnutzung Ihres Zentralstaubsaugers.

Der Begriff ist einfach: der Einzugschlauch mit der gewählten Länge ist im Leitungsnetz vom Staubsaugsystem verborgen, hinter einer Saugdose. Müssen Sie das Haus oder einen kleinen Schaden in der Küche säubern? Es reicht Ihnen, die Saugdose zu öffnen, die Schlauchlänge, die Sie brauchen, herauszunehmen, dort Ihre Zubehöerteile anzuschließen und Ihr Gerät an der Saugdose zu starten. Nichts Leichteres! Wenn Sie fertig sind, zieht sich der Schlauch schnell wieder ein, Dank der Saugkraft von Ihrem Gerät.

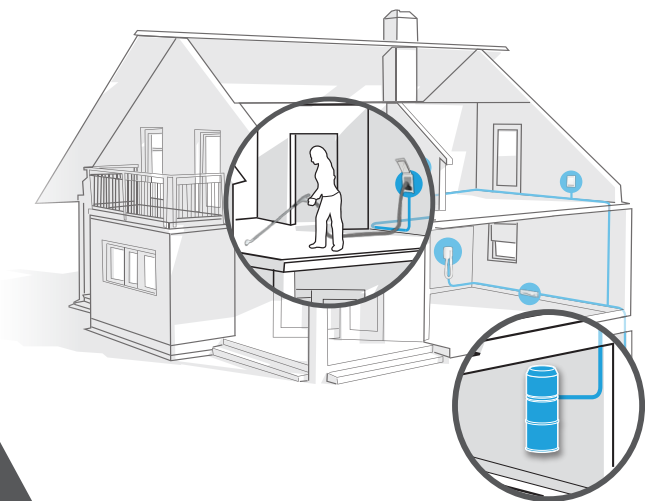

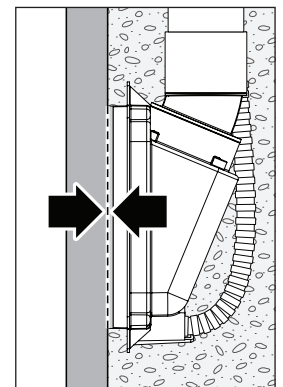
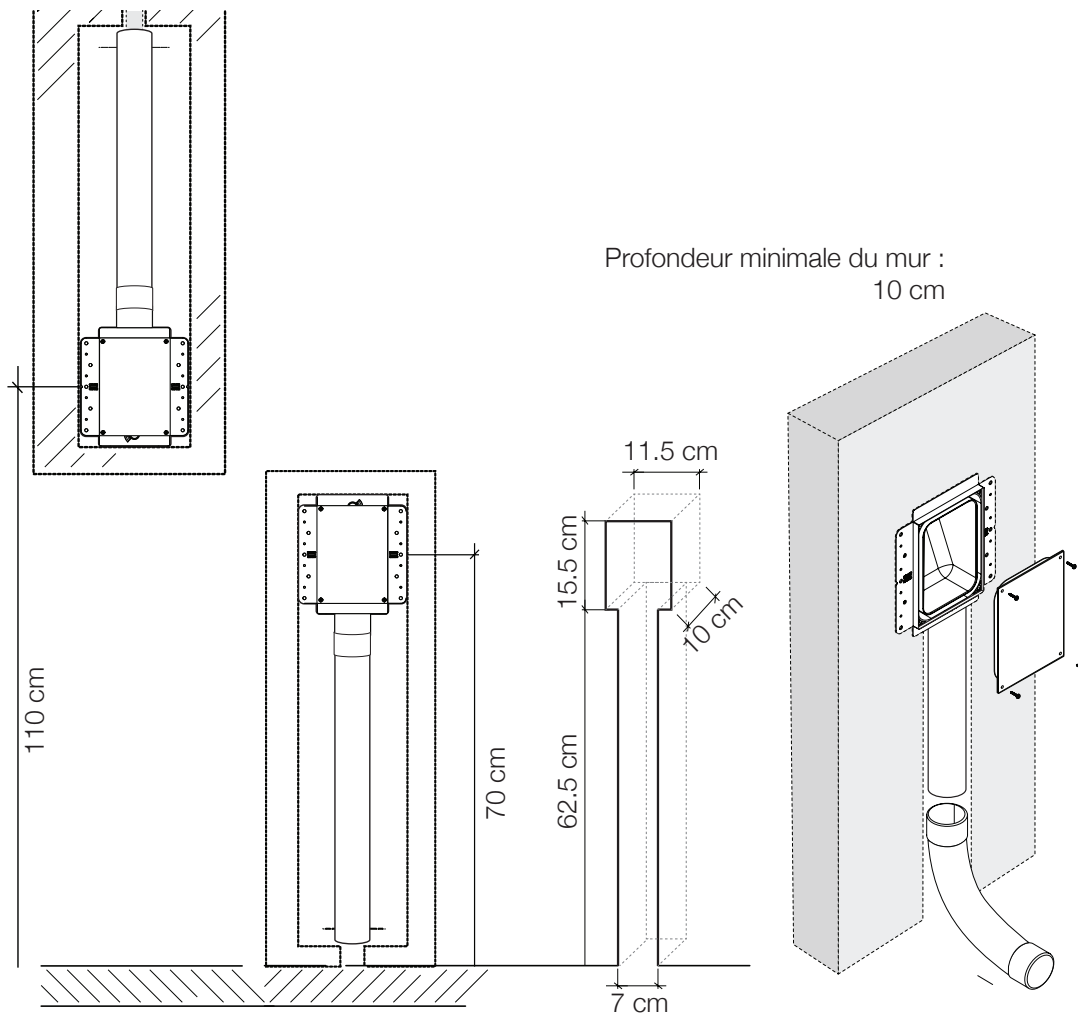
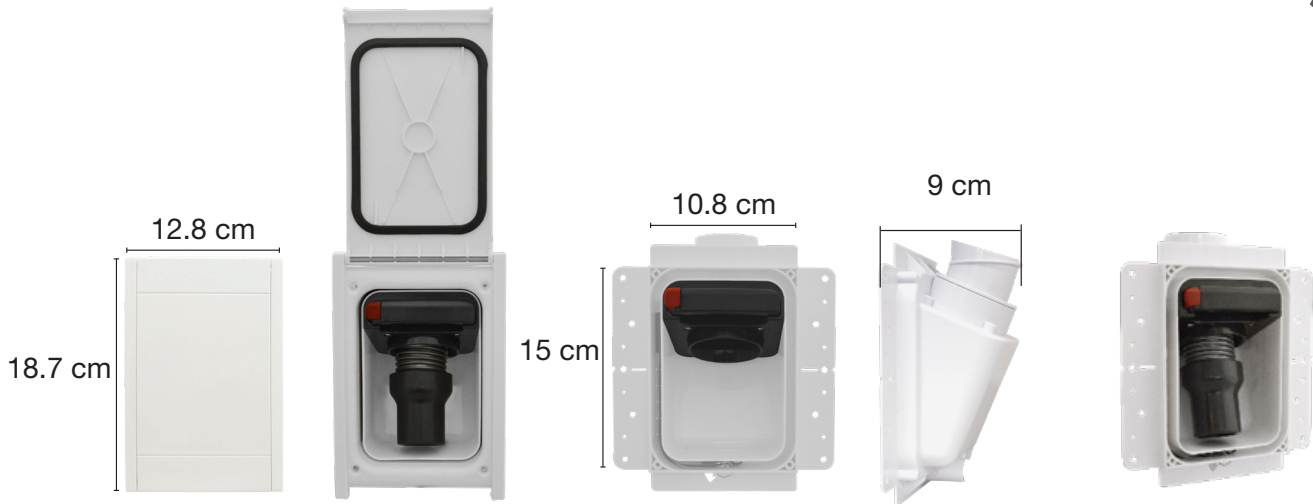

Installer la prise à la hauteur requise. S'assurer que le couvercle temporaire affleure sur le mur brut.

ITNN - ØØ - XXE

- Ensemble d'accessoires Retraflex
- Retraflex Zubehörset
- Retraflex attachment kit
- Kit de accesorios Retraflex

9.1 m	30'	• 30 •
12.2 m	40'	• 40 •
15.2 m	50'	• 50 •
18.3 m	60'	• 60 •



1



- (1X) **IT302130** - 9.1 m (30')
OU / ODER / OR / O
 (1X) **IT302140** - 12.2 m (40')
OU / ODER / OR / O
 (1X) **IT302150** - 15.2 m (50')
OU / ODER / OR / O
 (1X) **IT302160** - 18.3 m (60')



ITRETPO201 (1X)



2

ou / oder / or / o

3



4



5



- (1X) **IT402130** - 9.1 m (30')
OU / ODER / OR / O
 (1X) **IT402140** - 12.2 m (40')
OU / ODER / OR / O
 (1X) **IT402150** - 15.2 m (50')
OU / ODER / OR / O
 (1X) **IT402160** - 18.3 m (60')

ITRNN - ØØ - XXE

- Ensemble d'accessoires Retraflex
- Retraflex Zubehörset
- Retraflex attachment kit
- Kit de accesorios Retraflex

9.1 m	30'	• 30 •
12.2 m	40'	• 40 •
15.2 m	50'	• 50 •
18.3 m	60'	• 60 •

1. **HSP0IG55** (1X)
 2. **TENSNN01** (1X)
 3. **TBMANEXS** (1X)
 4. **TABRCADG** (1X)
 5. **TABRMANSUP** (1X)



1

ITRETP0201 (1X)

- (1X) **IT302130** - 9.1 m (30')
OU / ODER / OR / O
- (1X) **IT302140** - 12.2 m (40')
OU / ODER / OR / O
- (1X) **IT302150** - 15.2 m (50')
OU / ODER / OR / O
- (1X) **IT302160** - 18.3 m (60')



2

ou / oder / or / o



3

4

5

- 1. **TBORFPOI34 (1X)**
- 2. **TENSNN01 (1X)**
- 3. **TBMANEXS (1X)**
- 4. **TABRCADG (1X)**
- 5. **TABRMANSUP (1X)**

- (1X) **IT402130** - 9.1 m (30')
OU / ODER / OR / O
- (1X) **IT402140** - 12.2 m (40')
OU / ODER / OR / O
- (1X) **IT402150** - 15.2 m (50')
OU / ODER / OR / O
- (1X) **IT402160** - 18.3 m (60')

ITNN - ØØ - RFC

- **Ensemble d'accessoires Retraflex avec poignée RF complète**
- **Zuberhörset Retraflex mit komplett Funkhangriff**
- Retraflex attachment kit with complete RF handle
- Conjunto de accesorios Retraflex con empuñadura RF completa

9.1 m	30'	• 30 •
12.2 m	40'	• 40 •
15.2 m	50'	• 50 •
18.3 m	60'	• 60 •

ITRNN - ØØ - RFC

- **Ensemble d'accessoires Retraflex avec poignée RF complète**
- **Zuberhörset Retraflex mit komplett Funkhangriff**
- Retraflex attachment kit with complete RF handle
- Conjunto de accesorios Retraflex con empuñadura RF completa

9.1 m	30'	• 30 •
12.2 m	40'	• 40 •
15.2 m	50'	• 50 •
18.3 m	60'	• 60 •

ITNN - ØØ - RFS

- Ensemble d'accessoires Retraflex avec poignée RF seule
- Zuberhörset Retraflex mit einzige Funkhandgriff
- Retraflex attachment kit with single RF handle
- Conjunto de accesorios Retraflex con empuñadura RF sola

9.1 m	30'	• 30 •
12.2 m	40'	• 40 •
15.2 m	50'	• 50 •
18.3 m	60'	• 60 •

ITRNN - ØØ - RFS

- Ensemble d'accessoires Retraflex avec poignée RF seule
- Zuberhörset Retraflex mit einzige Funkhandgriff
- Retraflex attachment kit with additional RF handle
- Conjunto de accesorios Retraflex con empuñadura RF sola

9.1 m	30'	• 30 •
12.2 m	40'	• 40 •
15.2 m	50'	• 50 •
18.3 m	60'	• 60 •

ITINSRETN

- Ensemble d'installation Retraflex
- Retraflex Installationset
- Retraflex installation kit
- Kit de instalación Retraflex

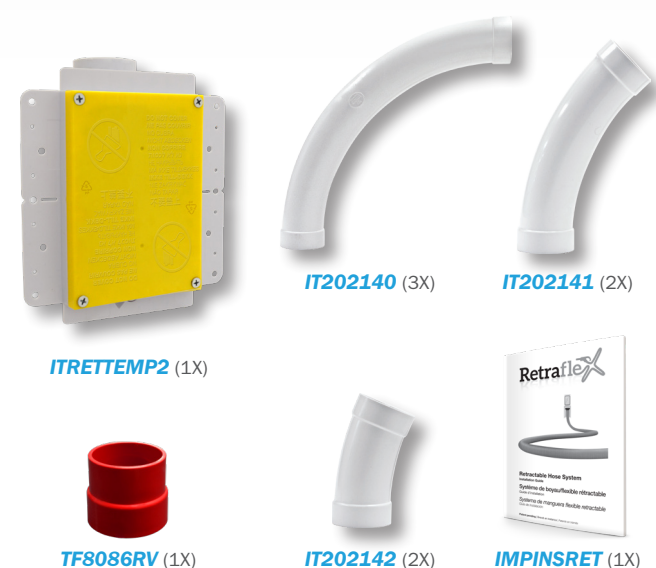



HSP0IG55

- **Poignée complète avec barrure**
- **Handgriff mit Knopf**
- Complete handle with button lock
- Empuñadura completa con bloqueo



TBORFP0134

- **Poignée RF complète**
- **Funkhandgriff komplett**
- Complete RF handle
- Empuñadura RF completa

Attention nouvelle fréquence, non compatible avec l'ancienne version, veuillez nous consulter
Achtung! Neue Frequenz. Nicht kompatibel mit frühere version. Kontaktieren Sie uns.
Pay attention, new frequency, not compatible with old version. Contact us.
Ojo, nueva frecuencia, no compatible con la antigua. Consultarnos.



TBORFP0123

- **Poignée RF seule**
- **RF Handgriff einzig**
- Additional RF handle
- Empuñadura RF Sola

Attention nouvelle fréquence, non compatible avec l'ancienne version, veuillez nous consulter
Achtung! Neue Frequenz. Nicht kompatibel mit frühere version. Kontaktieren Sie uns.
Pay attention, new frequency, not compatible with old version. Contact us.
Ojo, nueva frecuencia, no compatible con la antigua. Consultarnos.



TBORFTRAN2

- **Transfo pour poignée RF**
- **Netzanschluss allein für Funkhandgriff**
- Power supply for RF handle
- Alimentación sola para empuñadura RF



TBORFBATT

- **Piles pour poignée sans fil (2x)**
- **Funkhandgriffbatterien**
- Wireless handle batteries (2x)
- Baterías de mango inalámbrico



TBORFREC1

- Récepteur poignée RF
- Empfänger für Funkhandgriff
- Receiver for RF handle
- Receptor empuñadura RF

Attention nouvelle fréquence, non compatible avec l'ancienne version, veuillez nous consulter
 Achtung! Neue Frequenz. Nicht kompatibel mit frühere version. Kontaktieren Sie uns.
 Pay attention, new frequency, not compatible with old version. Contact us.
 Ojo, nueva frecuencia, no compatible con la antigua. Consultarnos.



TBORFEMEN1

- Émetteur 915mhz
- Insert 915mhz
- Insert 915mhz
- Emisor 915mhz



ITRETTEMP2

- Prise Retraflex complète avec plaque de recouvrement intégrée
- Komplette Retraflex Dose mit integriertem Putzdeckel
- Retraflex inlet with integrated cover plate
- Toma Retraflex completa con tapa integrada



ITRETTEMP4

- Prise Retraflex sans barrure pour installation dans le béton avec plaque de recouvrement intégrée
- Retraflex Dose ohne Verriegelung zum Einbau in Beton mit integrierten Putzdeckel
- No lock mechanism Retraflex inlet for concrete with cover plate
- Toma Retraflex sin empuñadura para instalación en hormigón con placa temporal integrada



ITRETPO201

- Porte Retraflex
- Retraflex Tür
- Retraflex door
- Puerta Retraflex

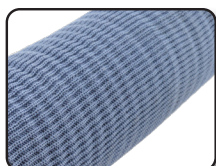
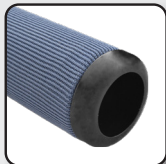

IT3021 · _ _

- **Flexible avec recouvre-flexible**
- **Schlauch mit Schlauchüberzug**
- Hose with hose cover
- Manguera con calcetín

9.1 m	30'	· 30
12.2 m	40'	· 40
15.2 m	50'	· 50
18.3 m	60'	· 60

IT4021 · _ _

- **Flexible standard**
- **Schlauch Standard**
- Standard hose
- Manguera estándar

9.1 m	30'	· 30
12.2 m	40'	· 40
15.2 m	50'	· 50
18.3 m	60'	· 60

TBVA · _ _ · BL1

- **Recouvre-flexible pour Retraflex**
- **Schlauchüberzug für Retraflex**
- Retraflex hose cover
- Funda para manguera Retraflex

9.1 m	30'	· 30
12.2 m	40'	· 40
15.2 m	50'	· 50
18.3 m	60'	· 60



IT202136R

- **Clip flexible pour flexible 35 mm sans chaussette**
- **Druckring für Schlauch, 35mm ohne Überzug**
- Flexible clip for 35 mm hose without sock
- Clip manguera para flexible 35 mm sin funda

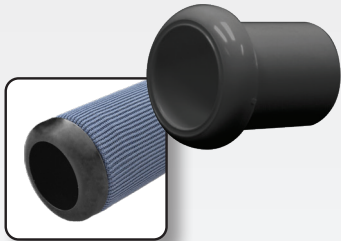

IT202132

- **Embout flexible Retraflex chaussette côté prise**
- **Endstück für Retraflex Schlauch mit Überzug Dose Seite**
- Retraflex hose end cap for inlet end
- Adaptador manguera Retraflex lado toma



IT202130

- **Adaptateur embout flexible Retraflex**
- **Endstückadapter Retraflex Schlauch**
- Adapter Retraflex hose
- Adaptador manguera Retraflex



TBADABS15

- **Embout complet pour flexible rétractable avec recouvre-flexible**
- **Ansatzstück komplett für Einzugschlauch mit Überzug**
- Complete hose end for retractable hose with hose cover
- Boquilla completa para manguera retráctil con funda

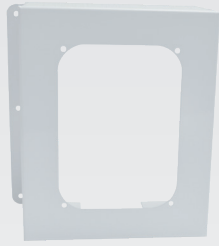

ITRET002

- **Boîtier pour cabinet (Retraflex II)**
- **Unterputz Dose (Retraflex II)**
- Casing for cabinets (Retraflex II)
- Cajetín para gabinete (Retraflex II)



TFATTAVA

- **Accroche Vacsocks**
- **Platte Halter für Vacsoc**
- Flat tie-wrap for Vacsoc
- Lazo plano para Vacsoc



IT420115

- **Adaptateur flexible-poignée**
- **Endstück Schlauchhandgriff**
- Hose-handle adaptor
- Adaptador manguera-empuñadura



ITRET002

- **Commutateur Reed**
- **Schalter Reed**
- Reed switch
- Interruptor de láminas

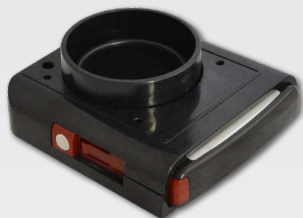

ITRET023

- **Barrure/poignée de remplacement complète (Retraflex I)**
- **Knopf/ Kompletter Ersatzhandgriff (Retraflex I)**
- Complete replacement lock/handle (Retraflex I)
- Empuñadura de repuesto (Retraflex I)



ITRET016

- **Anneau de caoutchouc pour mécanisme de barrure (Retraflex I)**
- **Gummi Dichtung für Klemm Mechanismus (Retraflex I)**
- Rubber ring for locking mechanism (Retraflex I)
- Junta de caucho para mecanismo cierre (Retraflex I)



ITRET223

- **Barrure poignée prise Retraflex II**
- **Verriegelung für Handgriff Retraflex II**
- Lock for Retraflex II handle
- Empuñadura para toma Retraflex II



ITRET216

- **Joint caoutchouc Retraflex II**
- **Gummidichtung Retraflex II**
- Retraflex II rubber seal
- Junta caucho Retraflex II



ITRET001

- **Vis pour porte Retraflex**
- **Schraubenset für Retraflex Tür**
- Screw for Retraflex door
- Tornillo para puerta Retraflex



ITRET004

- **Vis pour la barrure/poignée**
- **Schraubenset für Einbaumodul**
- Screw for the lock/handle
- Tornillo para empuñadura



ITRET021

- **Vis pour plaque de protection Retraflex**
- **Schraubenset für Retraflex Putzdeckel**
- Screw for cover plate
- Tornillo para placa de protección Retraflex



IT202140

- **Blanc 90°**
- **Weiß 90°**
- White 90°
- Blanco 90°



IT202141

- **Blanc 45°**
- **Weiß 45°**
- White 45°
- Blanco 45°



IT202142

- **Blanc 22.5°**
- **Weiß 22.5°**
- White 22.5°
- Blanco 22.5°



retraflex.com

Siège Social
Head Office
Sede social | Hauptsitz

Trovac QC

3, rue Marcel-Ayotte
Blainville (Québec)
J7C 5L7 Canada

T 450 434.2233
1 800 361.9553

F 450 434.6111
888 232.9485

Centre de distribution | Distribution Center
Centro de distribución | Vertriebszentrum

Trovac BC

108 - 3560, 190th Street
Surrey (BC)
V3Z 0P6 Canada

T 604 514.7005
1 800 665.2500

Trovac ON

921 Barton Street, unit #1
Stoney Creek (Ontario)
L8E 5P5 Canada

T 289 396.9405
1 877 283.5373

Trovac USA

3707 Lathrop Street
South Bend IN 46628

T 1 800 361 9553
F 1 888 232 9485

Trovac Europe

16, rue du Stade
44170 Treffieux, France

T 33(0)2.40.51.44.60
No vert : +33(0).800.800.393
info@trovac.com